



Silky



GOMBOY7

Blade length 210 mm / 8.3 inch
 Teeth/30mm 7 large teeth
 SAW:Code No. 413-21
 Box/Carton 12/36
 Barcode No. 4903585413219
 BLADE:Code No. 295-21
 Box/Carton 12/120
 Barcode No. 4903585295211

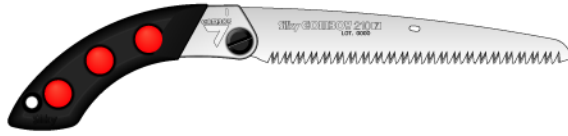

01

GOMBOY7

Blade length 240 mm / 9.5 inch
 Teeth/30mm 7 large teeth
 SAW:Code No. 413-24
 Box/Carton 12/36
 Barcode No. 4903585413240
 BLADE:Code No. 295-24
 Box/Carton 12/120
 Barcode No. 4903585295242



02

GOMBOY7

Blade length 270 mm / 10.6 inch
 Teeth/30mm 6 large teeth
 SAW:Code No. 413-27
 Box/Carton 12/36
 Barcode No. 4903585413271
 BLADE:Code No. 295-27
 Box/Carton 12/120
 Barcode No. 4903585295273



03

GOMBOY7

Blade length 300 mm / 11.8 inch
 Teeth/30mm 6 large teeth
 SAW:Code No. 413-30
 Box/Carton 12/36
 Barcode No. 4903585413301
 BLADE:Code No. 295-30
 Box/Carton 12/120
 Barcode No. 4903585295303



04

GOMBOY7

Blade length 210 mm / 8.3 inch
 Teeth/30mm 10 medium teeth
 SAW:Code No. 411-21
 Box/Carton 12/36
 Barcode No. 4903585411215
 BLADE:Code No. 122-21
 Box/Carton 12/120
 Barcode No. 4903585122210

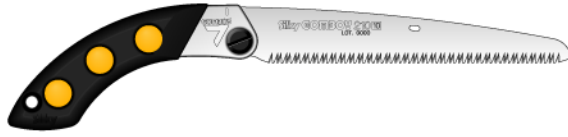

05

GOMBOY7

Blade length 240 mm / 9.5 inch
 Teeth/30mm 10 medium teeth
 SAW:Code No. 411-24
 Box/Carton 12/36
 Barcode No. 4903585411246
 BLADE:Code No. 122-24
 Box/Carton 12/120
 Barcode No. 4903585122241



06

GOMBOY7

Blade length 270 mm / 10.6 inch
 Teeth/30mm 10 medium teeth
 SAW:Code No. 411-27
 Box/Carton 12/36
 Barcode No. 4903585411277
 BLADE:Code No. 122-27
 Box/Carton 12/120
 Barcode No. 4903585122272



07

GOMBOY7

Blade length 300 mm / 11.8 inch
 Teeth/30mm 10 medium teeth
 SAW:Code No. 411-30
 Box/Carton 12/36
 Barcode No. 4903585411307
 BLADE:Code No. 122-30
 Box/Carton 12/120
 Barcode No. 4903585122302

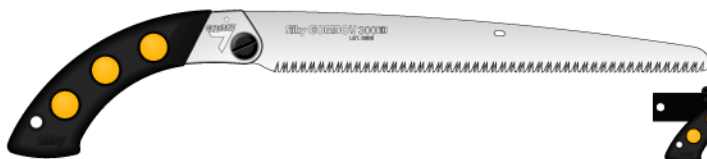

08

GOMBOY7

Blade length 210 mm / 8.3 inch
 Teeth/30mm 14 fine teeth
 SAW:Code No. 412-21
 Box/Carton 12/36
 Barcode No. 4903585412212
 BLADE:Code No. 291-21
 Box/Carton 12/120
 Barcode No. 4903585291213



09

GOMBOY7

Blade length 240 mm / 9.5 inch
 Teeth/30mm 14 fine teeth
 SAW:Code No. 412-24
 Box/Carton 12/36
 Barcode No. 4903585412243
 BLADE:Code No. 291-24
 Box/Carton 12/120
 Barcode No. 4903585291244

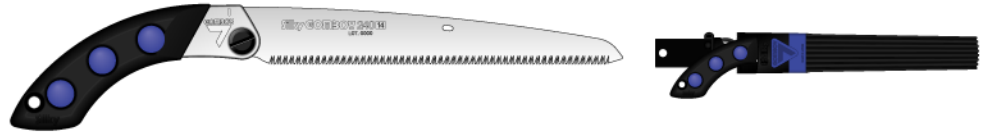

GOMBOY & 7
10

GOMBOY7

Blade length 270 mm / 10.6 inch
 Teeth/30mm 14 fine teeth
 SAW:Code No. 412-27
 Box/Carton 12/36
 Barcode No. 4903585412274
 BLADE:Code No. 291-27
 Box/Carton 12/120
 Barcode No. 4903585291275

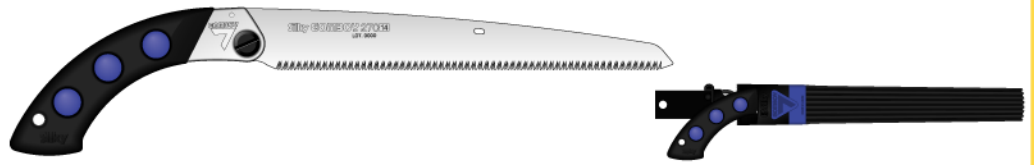

11

GOMBOY7

Blade length 300 mm / 11.8 inch
 Teeth/30mm 14 fine teeth
 SAW:Code No. 412-30
 Box/Carton 12/36
 Barcode No. 4903585412304
 BLADE:Code No. 291-30
 Box/Carton 12/120
 Barcode No. 4903585291305

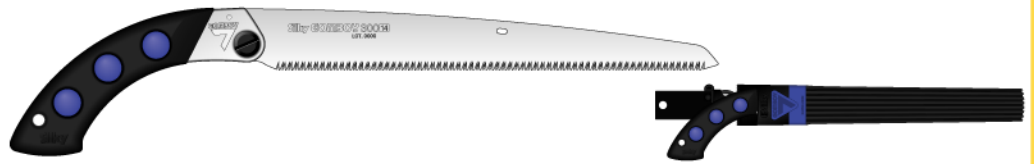

12

GOMBOY7 2000

Blade length 300 mm / 11.8 inch
 Teeth/30mm 6.5 large teeth
 SAW:Code No. 414-30
 Box/Carton 12/36
 Barcode No. 4903585414308
 BLADE:Code No. 297-30
 Box/Carton 12/120
 Barcode No. 4903585297307

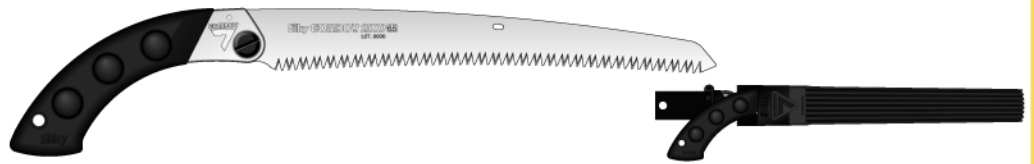

13

GOMBOY

Blade length 210 mm / 8.3 inch
 Teeth/30mm 7 large teeth
 SAW:Code No. 294-21
 Box/Carton 12/72
 Barcode No. 4903585294214
 BLADE:Code No. 295-21
 Box/Carton 12/120
 Barcode No. 4903585295211

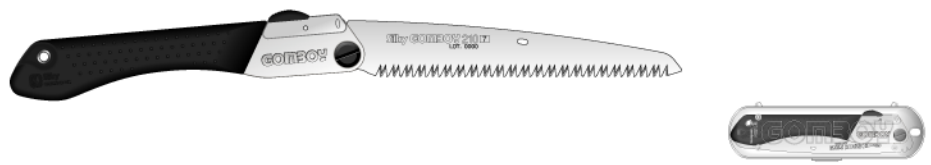

14

GOMBOY

Blade length 240 mm / 9.5 inch
 Teeth/30mm 7 large teeth
 SAW:Code No. 294-24
 Box/Carton 12/72
 Barcode No. 4903585294245
 BLADE:Code No. 295-24
 Box/Carton 12/120
 Barcode No. 4903585295242



15

GOMBOY

Blade length 270 mm / 10.6 inch
 Teeth/30mm 6 large teeth
 SAW:Code No. 294-27
 Box/Carton 12/72
 Barcode No. 4903585294276
 BLADE:Code No. 295-27
 Box/Carton 12/120
 Barcode No. 4903585295273



16

GOMBOY

Blade length 300 mm / 11.8 inch
 Teeth/30mm 6 large teeth
 SAW:Code No. 294-30
 Box/Carton 12/72
 Barcode No. 4903585294306
 BLADE:Code No. 295-30
 Box/Carton 12/120
 Barcode No. 4903585295303



17

GOMBOY

Blade length 210 mm / 8.3 inch
 Teeth/30mm 10 medium teeth
 SAW:Code No. 121-21
 Box/Carton 12/72
 Barcode No. 4903585121213
 BLADE:Code No. 122-21
 Box/Carton 12/120
 Barcode No. 4903585122210



18

GOMBOY & 7

GOMBOY

Blade length 240 mm / 9.5 inch
 Teeth/30mm 10 medium teeth
 SAW:Code No. 121-24
 Box/Carton 12/72
 Barcode No. 4903585121244
 BLADE:Code No. 122-24
 Box/Carton 12/120
 Barcode No. 4903585122241



19

GOMBOY

Blade length 270 mm / 10.6 inch
 Teeth/30mm 10 medium teeth
 SAW:Code No. 121-27
 Box/Carton 12/72
 Barcode No. 4903585121275
 BLADE:Code No. 122-27
 Box/Carton 12/120
 Barcode No. 4903585122272



20

GOMBOY

Blade length 300 mm / 11.8 inch
 Teeth/30mm 10 medium teeth
 SAW:Code No. 121-30
 Box/Carton 12/72
 Barcode No. 4903585121305
 BLADE:Code No. 122-30
 Box/Carton 12/120
 Barcode No. 4903585122302



21

GOMBOY

Blade length 210 mm / 8.3 inch
 Teeth/30mm 14 fine teeth
 SAW:Code No. 290-21
 Box/Carton 12/72
 Barcode No. 4903585290216
 BLADE:Code No. 291-21
 Box/Carton 12/120
 Barcode No. 4903585291213



22

GOMBOY

Blade length 240 mm / 9.5 inch
 Teeth/30mm 14 fine teeth
 SAW:Code No. 290-24
 Box/Carton 12/72
 Barcode No. 4903585290247
 BLADE:Code No. 291-24
 Box/Carton 12/120
 Barcode No. 4903585291244



23

GOMBOY

Blade length 270 mm / 10.6 inch
 Teeth/30mm 14 fine teeth
 SAW:Code No. 290-27
 Box/Carton 12/72
 Barcode No. 4903585290278
 BLADE:Code No. 291-27
 Box/Carton 12/120
 Barcode No. 4903585291275



24

GOMBOY

Blade length 300 mm / 11.8 inch
 Teeth/30mm 14 fine teeth
 SAW:Code No. 290-30
 Box/Carton 12/72
 Barcode No. 4903585290308
 BLADE:Code No. 291-30
 Box/Carton 12/120
 Barcode No. 4903585291305



25

SKATTBOY

Blade length 210 mm / 8.3 inch
 Teeth/30mm 20 extra fine teeth
 SAW:Code No. 292-21
 Box/Carton 12/72
 Barcode No. 4903585292227
 BLADE:Code No. 293-21
 Box/Carton 12/120
 Barcode No. 4903585293217

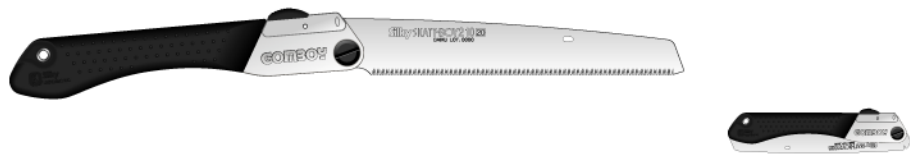

26

SKATTBOY

Blade length 240 mm / 9.5 inch
 Teeth/30mm 20 extra fine teeth
 SAW:Code No. 292-24
 Box/Carton 12/72
 Barcode No. 4903585292258
 BLADE:Code No. 293-24
 Box/Carton 12/120
 Barcode No. 4903585293248

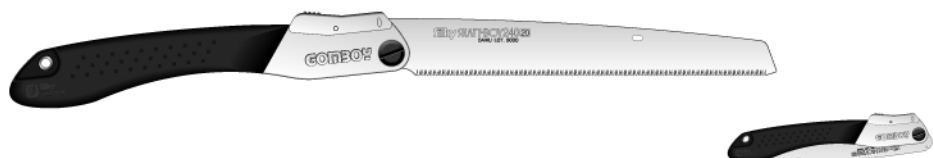

27

FOLDING SAW

POCKETBOY

Blade length 130 mm / 5.0 inch
 Teeth/30mm 8 large teeth
 SAW:Code No. 346-13
 Box/Cartron 12/72
 Barcode No. 4903585346135
 BLADE:Code No. 347-13
 Box/Cartron 12/120
 Barcode No. 4903585347132

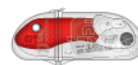

28

POCKETBOY

Blade length 170 mm / 6.7 inch
 Teeth/30mm 8 large teeth
 SAW:Code No. 346-17
 Box/Cartron 12/72
 Barcode No. 4903585346173
 BLADE:Code No. 347-17
 Box/Cartron 12/120
 Barcode No. 4903585347170

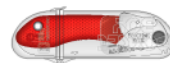

29

POCKETBOY

Blade length 130 mm / 5.0 inch
 Teeth/30mm 10 medium teeth
 SAW:Code No. 340-13
 Box/Cartron 12/72
 Barcode No. 4903585340133
 BLADE:Code No. 341-13
 Box/Cartron 12/120
 Barcode No. 4903585341130



30

POCKETBOY

Blade length 170 mm / 6.7 inch
 Teeth/30mm 10 medium teeth
 SAW:Code No. 340-17
 Box/Cartron 12/72
 Barcode No. 4903585340171
 BLADE:Code No. 341-17
 Box/Cartron 12/120
 Barcode No. 4903585341178

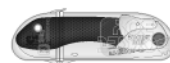

31

POCKETBOY

Blade length 130 mm / 5.0 inch
 Teeth/30mm 20 fine teeth
 SAW:Code No. 342-13
 Box/Cartron 12/72
 Barcode No. 4903585342137
 BLADE:Code No. 343-13
 Box/Cartron 12/120
 Barcode No. 4903585343134



32

POCKETBOY

Blade length 170 mm / 6.7 inch
 Teeth/30mm 20 fine teeth
 SAW:Code No. 342-17
 Box/Cartron 12/72
 Barcode No. 4903585342175
 BLADE:Code No. 343-17
 Box/Cartron 12/120
 Barcode No. 4903585343172

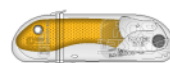

33

POCKETBOY

Blade length 130 mm / 5.0 inch
 Teeth/30mm 26 extra fine teeth
 SAW:Code No. 344-13
 Box/Cartron 12/72
 Barcode No. 4903585344131
 BLADE:Code No. 345-13
 Box/Cartron 12/120
 Barcode No. 4903585345138



34

POCKETBOY

Blade length 170 mm / 6.7 inch
 Teeth/30mm 26 extra fine teeth
 SAW:Code No. 344-17
 Box/Cartron 12/72
 Barcode No. 4903585344179
 BLADE:Code No. 345-17
 Box/Cartron 12/120
 Barcode No. 4903585345176



35

ACCEL

Blade length 160 mm / 6.3 inch
 Teeth/30mm 7.5 large teeth
 SAW:Code No. 110-16
 Box/Cartron 12/96
 Barcode No. 4903585110163
 BLADE:Code No. 112-16
 Box/Cartron 12/120
 Barcode No. 4903585112167



36

SUPER-ACCEL21

Blade length 210 mm / 8.3 inch
 Teeth/30mm 7.5 large teeth
 SAW:Code No. 119-21
 Box/Carton 12/72
 Barcode No. 4903585119210
 BLADE:Code No. 120-21
 Box/Carton 12/120
 Barcode No. 4903585120216



37

SUPER-ACCEL21

Blade length 210 mm / 8.3 inch
 Teeth/30mm 14 fine teeth
 SAW:Code No. 117-21
 Box/Carton 12/72
 Barcode No. 4903585117216
 BLADE:Code No. 118-21
 Box/Carton 12/120
 Barcode No. 4903585118213



38

F180

Blade length 180 mm / 7.0 inch
 Teeth/30mm 7.5 large teeth
 SAW:Code No. 143-18
 Box/Carton 12/72
 Barcode No. 4903585143185
 BLADE:Code No. 144-18
 Box/Carton 12/120
 Barcode No. 4903585144182



39

F180

Blade length 180 mm / 7.0 inch
 Teeth/30mm 14 fine teeth
 SAW:Code No. 141-18
 Box/Carton 12/72
 Barcode No. 4903585141181
 BLADE:Code No. 142-18
 Box/Carton 12/120
 Barcode No. 4903585142188



40

TOPGUN

Blade length 200 mm / 7.9 inch
 Teeth/30mm 7.5 large teeth
 SAW:Code No. 133-20
 Box/Carton 12/72
 Barcode No. 4903585133209
 BLADE:Code No. 134-20
 Box/Carton 12/120
 Barcode No. 4903585134206



41

TOPGUN

Blade length 240 mm / 9.5 inch
 Teeth/30mm 7.5 large teeth
 SAW:Code No. 133-24
 Box/Carton 12/72
 Barcode No. 4903585133247
 BLADE:Code No. 134-24
 Box/Carton 12/120
 Barcode No. 4903585134244



42

OYAKATA

Blade length 270 mm / 10.6 inch
 Teeth/30mm 10 medium teeth
 SAW:Code No. 113-27
 Box/Carton 12/72
 Barcode No. 4903585113270
 BLADE:Code No. 114-27
 Box/Carton 12/120
 Barcode No. 4903585114277



43

OYAKATA

Blade length 270 mm / 10.6 inch
 Teeth/30mm 20 fine teeth
 SAW:Code No. 250-27
 Box/Carton 12/72
 Barcode No. 4903585250272
 BLADE:Code No. 251-27
 Box/Carton 12/120
 Barcode No. 4903585251279



44

BIGBOY

Blade length 360 mm / 14.2 inch
 Teeth/30mm 7 large teeth
 SAW:Code No. 354-36
 Box/Carton 12/48
 Barcode No. 4903585354369
 BLADE:Code No. 355-36
 Box/Carton 12/120
 Barcode No. 4903585355366



45

BIGBOY

Blade length 360 mm / 14.2 inch
 Teeth/30mm 10 medium teeth
 SAW:Code No. 350-36
 Box/Cartron 12/48
 Barcode No. 4903585350361
 BLADE:Code No. 351-36
 Box/Cartron 12/120
 Barcode No. 4903585351368



FOLDING SAW
46

BIGBOY

Blade length 360 mm / 14.2 inch
 Teeth/30mm 13 fine teeth
 SAW:Code No. 352-36
 Box/Cartron 12/48
 Barcode No. 4903585352365
 BLADE:Code No. 353-36
 Box/Cartron 12/120
 Barcode No. 4903585353362



47

BIGBOY 2000

Blade length 360 mm / 14.2 inch
 Teeth/30mm 6.5 extra large teeth
 SAW:Code No. 356-36
 Box/Cartron 12/72
 Barcode No. 4903585356363
 BLADE:Code No. 357-36
 Box/Cartron 12/120
 Barcode No. 4903585357360



48

WOODBAY

Blade length 240 mm / 9.5 inch
 Teeth/30mm 26 extra fine teeth
 SAW:Code No. 386-24
 Box/Cartron 12/72
 Barcode No. 4903585386247
 BLADE:Code No. 387-24
 Box/Cartron 12/120
 Barcode No. 4903585387244



WOODWORKING SAW
49

WOODBAY

Blade length 240 mm / 9.5 inch
 Teeth/30mm 32 extra fine teeth
 SAW:Code No. 388-24
 Box/Cartron 12/72
 Barcode No. 4903585388241
 BLADE:Code No. 389-24
 Box/Cartron 12/120
 Barcode No. 4903585389248



50

WOODBAY dozuki

Blade length 240 mm / 9.5 inch
 Teeth/30mm 32 extra fine teeth
 SAW:Code No. 384-24
 Box/Cartron 12/72
 Barcode No. 4903585384243
 BLADE:Code No. 385-24
 Box/Cartron 12/120
 Barcode No. 4903585385240

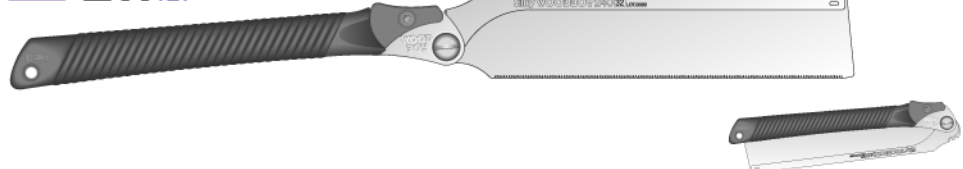

51

TSUBASA

Blade length 285 mm / 11.2 inch
 Teeth/30mm 14 medium teeth
 SAW:Code No. 334-28
 Box/Cartron 12/72
 Barcode No. 4903585334286
 BLADE:Code No. 335-28
 Box/Cartron 24/144
 Barcode No. 4903585335283



52

TSUBASA

Blade length 285 mm / 11.2 inch
 Teeth/30mm 18 fine teeth
 SAW:Code No. 332-28
 Box/Cartron 12/72
 Barcode No. 4903585332282
 BLADE:Code No. 333-28
 Box/Cartron 24/144
 Barcode No. 4903585333289



53

TSUBASA

Blade length 285 mm / 11.2 inch
 Teeth/30mm 22 extra fine teeth
 SAW:Code No. 330-28
 Box/Cartron 12/72
 Barcode No. 4903585330288
 BLADE:Code No. 331-28
 Box/Cartron 24/144
 Barcode No. 4903585331285



54

WOODWORKING SAW

MASTER

Blade length 330 mm / 13.0 inch
 Teeth/30mm 11 medium teeth
 SAW:Code No. 147-33
 Box/Carton 12/72
 Barcode No. 4903585147336
 BLADE:Code No. 148-333
 Box/Carton 24/144
 Barcode No. 4903585148357



55

MASTER

Blade length 360 mm / 14.2 inch
 Teeth/30mm 9 large teeth
 SAW:Code No. 149-36
 Box/Carton 12/72
 Barcode No. 4903585149361
 BLADE:Code No. 150-363
 Box/Carton 24/144
 Barcode No. 4903585150374



56

HIBIKI RYOBA

Blade length 210 mm / 8.3 inch
 Teeth/30mm 22 extra fine teeth
 SAW:Code No. 396-21
 Box/Carton 6/48
 Barcode No. 4903585396215
 BLADE:Code No. 397-21
 Box/Carton 12/120
 Barcode No. 4903585397212



57

SHEATHED SAW

MINI-MINI2 for wood

Blade length 150 mm / 5.9 inch
 Teeth/30mm 24 extra fine teeth
 SAW:Code No. 162-15
 Box/Carton 12/120
 Barcode No. 4903585162155
 BLADE:Code No. 163-15
 Box/Carton 12/120
 Barcode No. 4903585163152

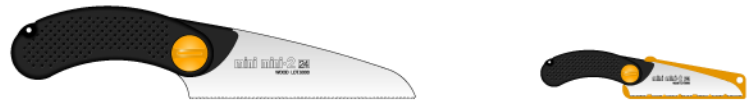

58

MINI-MINI2 for plastic

Blade length 150 mm / 5.9 inch
 Teeth/30mm 24 extra fine teeth
 SAW:Code No. 164-15
 Box/Carton 12/120
 Barcode No. 4903585164159
 BLADE:Code No. 165-15
 Box/Carton 12/120
 Barcode No. 4903585165156

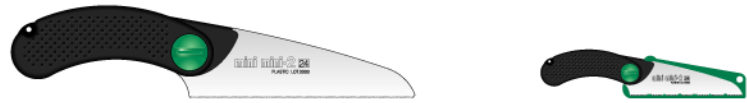

59

MINI-MINI2 for metal

Blade length 150 mm / 5.9 inch
 Teeth/30mm 42 extra fine teeth
 SAW:Code No. 166-15
 Box/Carton 12/120
 Barcode No. 4903585166153
 BLADE:Code No. 167-15
 Box/Carton 12/120
 Barcode No. 4903585167150

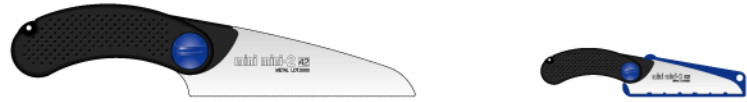

60

GINGA

Blade length 270 mm / 10.6 inch
 Teeth/30mm 10 medium teeth
 SAW:Code No. 224-27
 Box/Carton 12/72
 Barcode No. 4903585224273
 BLADE:Code No. 225-27
 Box/Carton 12/120
 Barcode No. 4903585225270

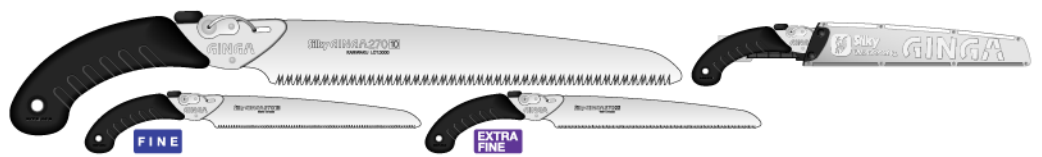

61

No.220-27 GINGA Carpentry and No.222-27 GINGA Bamboo are also available.

GOMTARO

Blade length 180 mm / 7.0 inch
 Teeth/30mm 8 large teeth
 SAW:Code No. 102-18
 Box/Carton 12/72
 Barcode No. 4903585102182
 BLADE:Code No. 103-18
 Box/Carton 12/120
 Barcode No. 4903585103189



62

GOMTARO

Blade length 210 mm / 8.3 inch
 Teeth/30mm 8 large teeth
 SAW:Code No. 102-21
 Box/Carton 12/72
 Barcode No. 4903585102212
 BLADE:Code No. 103-21
 Box/Carton 12/120
 Barcode No. 4903585103219

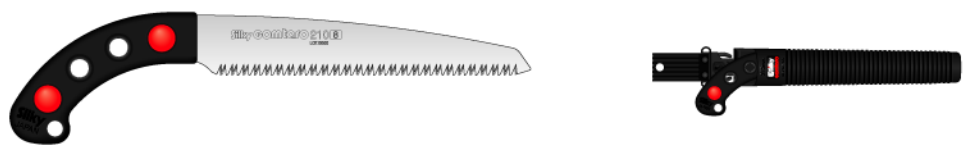

63

GOMTARO

Blade length 240 mm / 9.5 inch
 Teeth/30mm 8 large teeth
 SAW:Code No. 102-24
 Box/Cartron 12/72
 Barcode No. 4903585102243
 BLADE:Code No. 103-24
 Box/Cartron 12/120
 Barcode No. 4903585103240



64

GOMTARO

Blade length 270 mm / 10.6 inch
 Teeth/30mm 8 large teeth
 SAW:Code No. 102-27
 Box/Cartron 12/72
 Barcode No. 4903585102274
 BLADE:Code No. 103-27
 Box/Cartron 12/120
 Barcode No. 4903585103271



65

GOMTARO

Blade length 300 mm / 11.8 inch
 Teeth/30mm 8 large teeth
 SAW:Code No. 102-30
 Box/Cartron 12/72
 Barcode No. 4903585102304
 BLADE:Code No. 103-30
 Box/Cartron 12/120
 Barcode No. 4903585103301



66

GOMTARO

Blade length 240 mm / 9.5 inch
 Teeth/30mm 13 fine teeth
 SAW:Code No. 104-24
 Box/Cartron 12/72
 Barcode No. 4903585104247
 BLADE:Code No. 105-24
 Box/Cartron 12/120
 Barcode No. 4903585105244



67

GOMTARO

Blade length 270 mm / 10.6 inch
 Teeth/30mm 13 fine teeth
 SAW:Code No. 104-27
 Box/Cartron 12/72
 Barcode No. 4903585104278
 BLADE:Code No. 105-27
 Box/Cartron 12/120
 Barcode No. 4903585105275



68

GOMTARO

Blade length 300 mm / 11.8 inch
 Teeth/30mm 13 fine teeth
 SAW:Code No. 104-30
 Box/Cartron 12/72
 Barcode No. 4903585104308
 BLADE:Code No. 105-30
 Box/Cartron 12/120
 Barcode No. 4903585105305



69

GOMTARO Root-Cutting

Blade length 240 mm / 9.5 inch
 Teeth/30mm 8 large teeth
 SAW:Code No. 153-24
 Box/Cartron 12/72
 Barcode No. 4903585153245
 BLADE:Code No. 154-24
 Box/Cartron 12/120
 Barcode No. 4903585154242



70

GOMTARO Pro-Sentei

Blade length 240 mm / 9.5 inch
 Teeth/30mm 8-14 large teeth
 SAW:Code No. 108-24
 Box/Cartron 12/72
 Barcode No. 4903585108245
 BLADE:Code No. 109-24
 Box/Cartron 12/120
 Barcode No. 4903585109242



71

GOMTARO Pro-Sentei

Blade length 300 mm / 11.8 inch
 Teeth/30mm 8-14 large teeth
 SAW:Code No. 108-30
 Box/Cartron 12/72
 Barcode No. 4903585108306
 BLADE:Code No. 109-30
 Box/Cartron 12/120
 Barcode No. 4903585109303



72

GUNFIGHTER

Blade length	270 mm / 10.6 inch
Teeth/30mm	12 medium teeth
SAW:Code No.	362-27
Box/Carton	12/72
Barcode No.	4903585362272
BLADE:Code No.	363-27
Box/Carton	12/120
Barcode No.	4903585363279

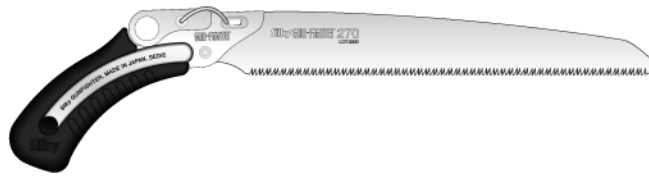
**ZUBAT**

Blade length	240 mm / 9.5 inch
Teeth/30mm	7.5 large teeth
SAW:Code No.	270-24
Box/Carton	12/48
Barcode No.	4903585270249
BLADE:Code No.	271-24
Box/Carton	12/120
Barcode No.	4903585271246

**ZUBAT**

Blade length	270 mm / 10.6 inch
Teeth/30mm	7.5 large teeth
SAW:Code No.	270-27
Box/Carton	12/48
Barcode No.	4903585270270
BLADE:Code No.	271-27
Box/Carton	12/120
Barcode No.	4903585271277

**ZUBAT**

Blade length	300 mm / 11.8 inch
Teeth/30mm	7.5 large teeth
SAW:Code No.	270-30
Box/Carton	12/48
Barcode No.	4903585270300
BLADE:Code No.	271-30
Box/Carton	12/120
Barcode No.	4903585271307

**ZUBAT**

Blade length	330 mm / 13.0 inch
Teeth/30mm	7.5 large teeth
SAW:Code No.	270-33
Box/Carton	12/48
Barcode No.	4903585270331
BLADE:Code No.	271-33
Box/Carton	12/120
Barcode No.	4903585271338

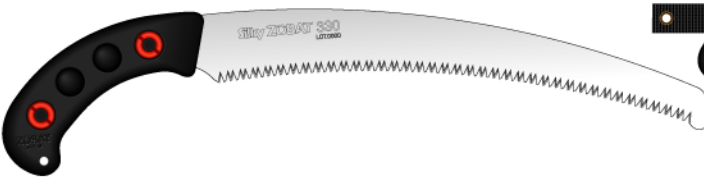
**ZUBAT**

Blade length	390 mm / 15.4 inch
Teeth/30mm	7.5 large teeth
SAW:Code No.	270-39
Box/Carton	6/24
Barcode No.	4903585270393
BLADE:Code No.	271-39
Box/Carton	—
Barcode No.	4903585271390

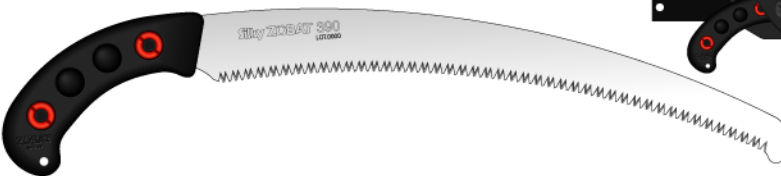
**NATANOKO 2000**

Blade length	330 mm / 13.0 inch
Teeth/30mm	6.5 extra large teeth
SAW:Code No.	401-33
Box/Carton	12/48
Barcode No.	4903585401339
BLADE:Code No.	402-33
Box/Carton	12/120
Barcode No.	4903585402336

**YAMABICO**

Blade length	330 mm / 13.0 inch
Teeth/30mm	6 extra large teeth
SAW:Code No.	407-33
Box/Carton	12/48
Barcode No.	4903585407331
BLADE:Code No.	408-33
Box/Carton	—
Barcode No.	4903585408338

**MASARU**

Blade length	330 mm / 13.0 inch
Teeth/30mm	5.5-7 extra large teeth
SAW:Code No.	127-33
Box/Carton	6/48
Barcode No.	4903585127338
BLADE:Code No.	128-33
Box/Carton	12/120
Barcode No.	4903585128335

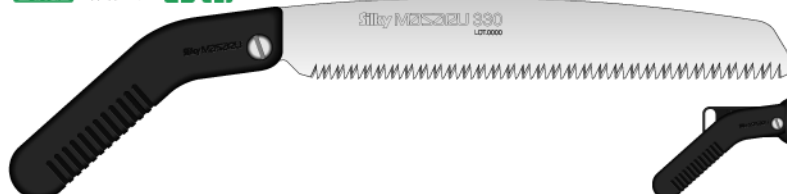

MASARU

Blade length	360 mm / 14.2 inch
Teeth/30mm	5.5-7 extra large teeth
SAW:Code No.	127-36
Box/Carton	6/48
Barcode No.	4903585127369
BLADE:Code No.	128-36
Box/Carton	12/120
Barcode No.	4903585128366



SHEATHED SAW
82

GENKI-TEMAGARI

Blade length	360 mm / 14.2 inch
Teeth/30mm	5-6.5 extra large teeth
SAW:Code No.	550-36
Box/Carton	12/72
Barcode No.	4903585550365

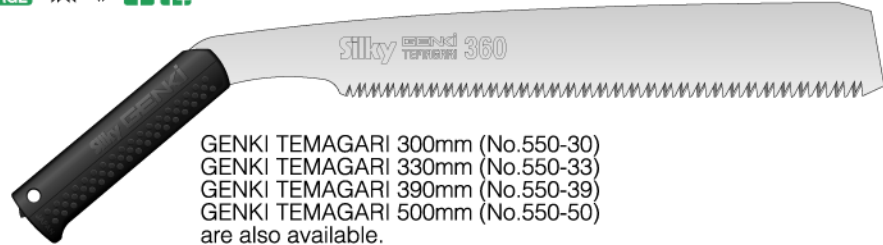

GENKI TEMAGARI 300mm (No.550-30)
GENKI TEMAGARI 330mm (No.550-33)
GENKI TEMAGARI 390mm (No.550-39)
GENKI TEMAGARI 500mm (No.550-50)
are also available.

83

ZORIN

Blade length	370 mm / 14.6 inch
Teeth/30mm	5-6.5 extra large teeth
SAW:Code No.	131-37
Box/Carton	6/24
Barcode No.	4903585131373
BLADE:Code No.	132-37
Box/Carton	12/120
Barcode No.	4903585132370

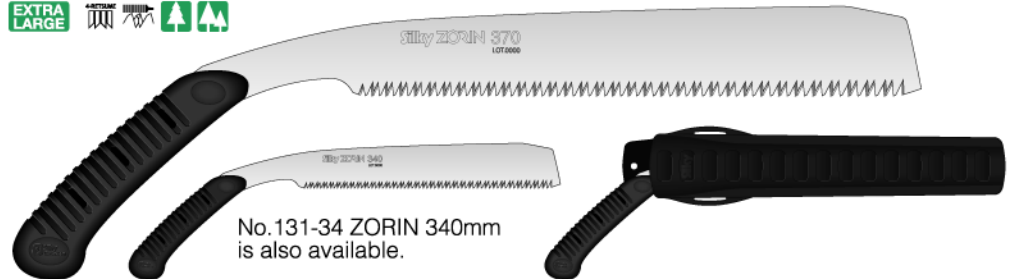

No.131-34 ZORIN 340mm
is also available.

84

KAMISORIME

Blade length	375 mm / 14.8 inch
Teeth/30mm	6.5 extra large teeth
SAW:Code No.	264-37
Box/Carton	6/24
Barcode No.	4903585264378
BLADE:Code No.	265-37
Box/Carton	12/—
Barcode No.	4903585265375

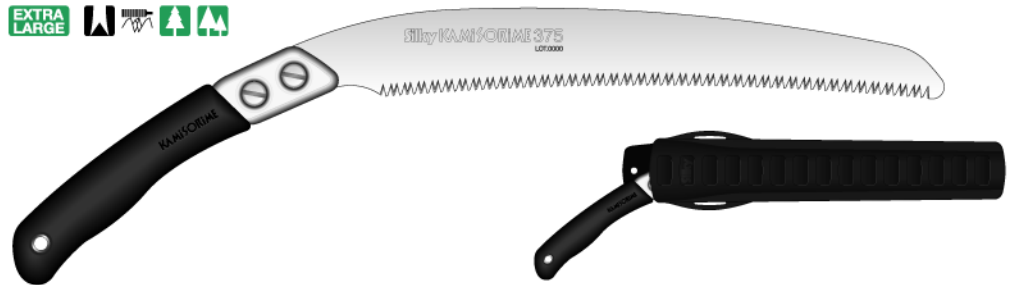

85

SUGOI

Blade length	360 mm / 14.2 inch
Teeth/30mm	6.5 extra large teeth
SAW:Code No.	390-36
Box/Carton	6/24
Barcode No.	4903585390367
BLADE:Code No.	391-36
Box/Carton	12/—
Barcode No.	4903585391364



86

SUGOI

Blade length	420 mm / 16.5 inch
Teeth/30mm	6.5 extra large teeth
SAW:Code No.	390-42
Box/Carton	6/24
Barcode No.	4903585390428
BLADE:Code No.	391-42
Box/Carton	12/—
Barcode No.	4903585391425



87

IBUKI

Blade length	390 mm / 15.4 inch
Teeth/30mm	6.5 extra large teeth
SAW:Code No.	275-39
Box/Carton	6/24
Barcode No.	4903585275398
BLADE:Code No.	276-39
Box/Carton	12/120
Barcode No.	4903585276395



88

FOLDING SAW

KATANABOY

Blade length	500 mm / 19.7 inch
Teeth/30mm	5 extra large teeth
SAW:Code No.	403-50
Box/Carton	—
Barcode No.	4903585403500
BLADE:Code No.	404-50
Box/Carton	—
Barcode No.	4903585404507



POLE SAW

HAYAUCHI 1-extension

Blade length	390 mm / 15.4 inch
Teeth/30mm	6.5 extra large teeth
SAW:Code No.	177-39
Box/Carton	4
Barcode No.	4903585177395
BLADE:Code No.	177-02-03
Box/Carton	10/60
Barcode No.	4903585177029
Blade with cover & pipe:Code No.	177-02-41
Box/Carton	2/36
Barcode No.	4903585177043

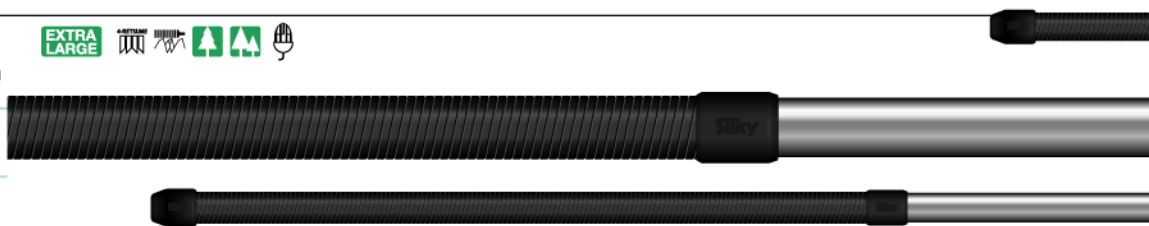

Extension range 2280~3700mm 7.5~12ft.

HAYAUCHI 2-extensions

Blade length	390 mm / 15.4 inch
Teeth/30mm	6.5 extra large teeth
SAW:Code No.	178-39
Box/Carton	4
Barcode No.	4903585178392
BLADE:Code No.	177-02-03
Box/Carton	10/60
Barcode No.	4903585177029
Blade with cover & pipe:Code No.	177-02-41
Box/Carton	2/36
Barcode No.	4903585177043



Extension range 2350~4900mm 7.7~16ft.

HAYAUCHI 3-extensions

Blade length	390 mm / 15.4 inch
Teeth/30mm	6.5 extra large teeth
SAW:Code No.	179-39
Box/Carton	4
Barcode No.	4903585179399
BLADE:Code No.	177-02-03
Box/Carton	10/60
Barcode No.	4903585177029
Blade with cover & pipe:Code No.	177-02-41
Box/Carton	2/36
Barcode No.	4903585177043



Extension range 2440~6300mm 8~21ft.

ZUBAT1200 1-extension

Blade length	330 mm / 13.0 inch
Teeth/30mm	7.5 large teeth
SAW:Code No.	272-12
Box/Carton	6
Barcode No.	4903585272120
BLADE:Code No.	271-33
Box/Carton	12/120
Barcode No.	4903585271338



Extension range 1750~2650mm 5.5~9ft.

ZUBAT1500 1-extension

Blade length	330 mm / 13.0 inch
Teeth/30mm	7.5 large teeth
SAW:Code No.	272-15
Box/Carton	6
Barcode No.	4903585272151
BLADE:Code No.	271-33
Box/Carton	12/120
Barcode No.	4903585271338



Extension range 2000~3300mm 6.6~11ft.

ZUBAT1800 1-extension

Blade length	330 mm / 13.0 inch
Teeth/30mm	7.5 large teeth
SAW:Code No.	272-18
Box/Carton	6
Barcode No.	4903585272182
BLADE:Code No.	271-33
Box/Carton	12/120
Barcode No.	4903585271338



Extension range 2350~3850mm 7.7~13ft.

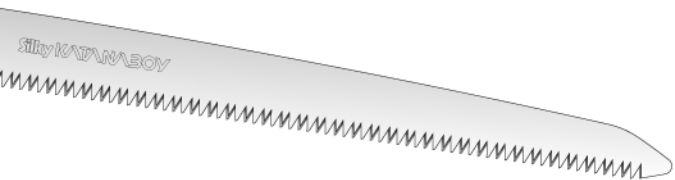

No.426-39 HAYAUCHI IPPON (2,440mm / 8-feet fixed length pole saw) is also available.

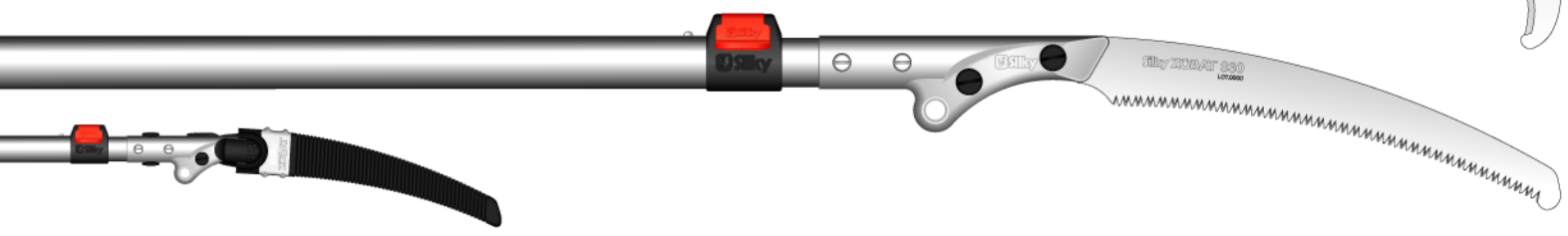
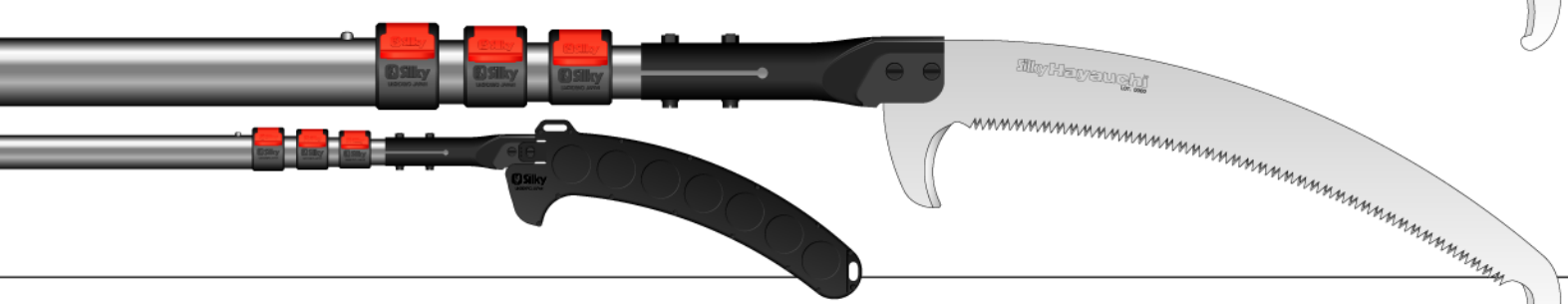
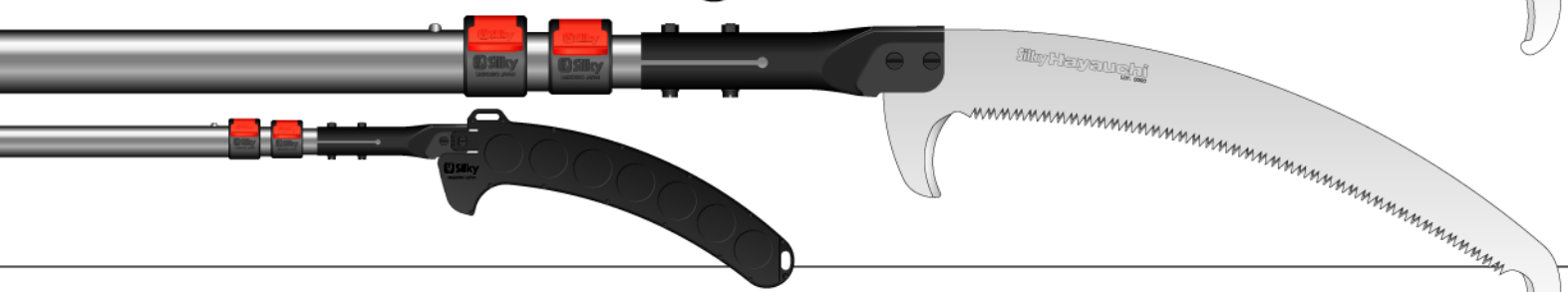
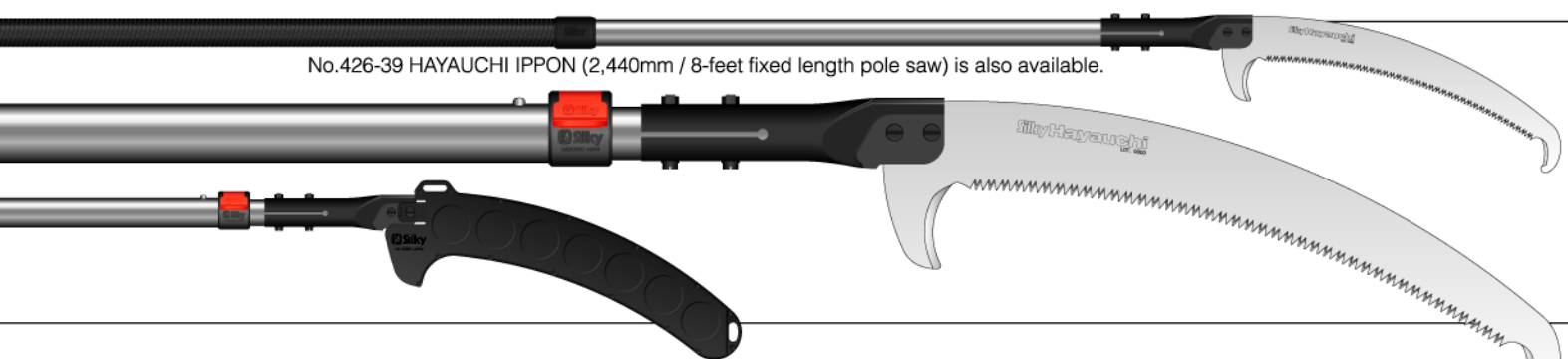

HAYATE

1-extension
 Blade length 420 mm / 16.5 inch
 Teeth/30mm 6.5 extra large teeth
 SAW:Code No. 370-42
 Box/Cartron 3
 Barcode No. 4903585370420
 BLADE:Code No. 373-42
 Box/Cartron 10/-
 Barcode No. 4903585373421
 SICKLE:Code No. 375-70
 Box/Cartron 10/-
 Barcode No. 4903585375708

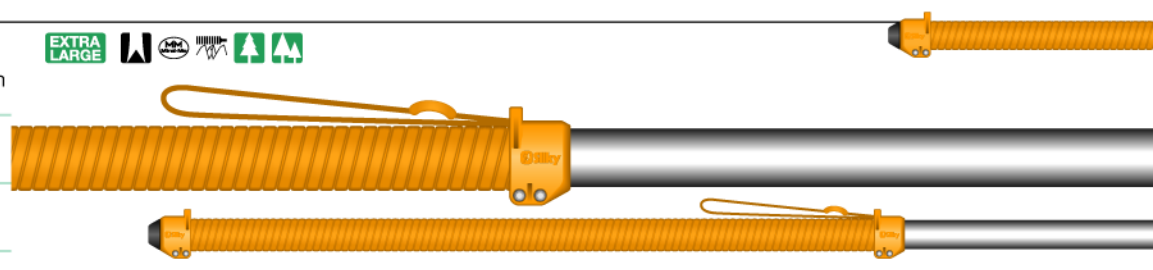

Extension range 2400 ~ 3800 mm 7.9 ~ 12 ft.

96

HAYATE

2-extensions
 Blade length 420 mm / 16.5 inch
 Teeth/30mm 6.5 extra large teeth
 SAW:Code No. 371-42
 Box/Cartron 3
 Barcode No. 4903585371427
 BLADE:Code No. 373-42
 Box/Cartron 10/-
 Barcode No. 4903585373421
 SICKLE:Code No. 375-70
 Box/Cartron 10/-
 Barcode No. 4903585375708

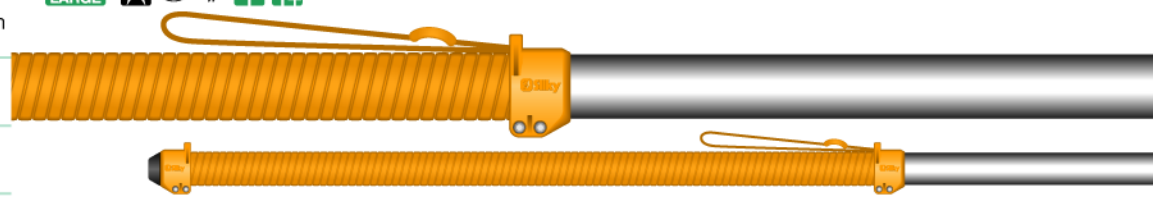

Extension range 2400 ~ 5000 mm 7.9 ~ 16 ft.

97

HAYATE

3-extensions
 Blade length 420 mm / 16.5 inch
 Teeth/30mm 6.5 extra large teeth
 SAW:Code No. 372-42
 Box/Cartron 3
 Barcode No. 4903585372424
 BLADE:Code No. 373-42
 Box/Cartron 10/-
 Barcode No. 4903585373421
 SICKLE:Code No. 375-70
 Box/Cartron 10/-
 Barcode No. 4903585375708

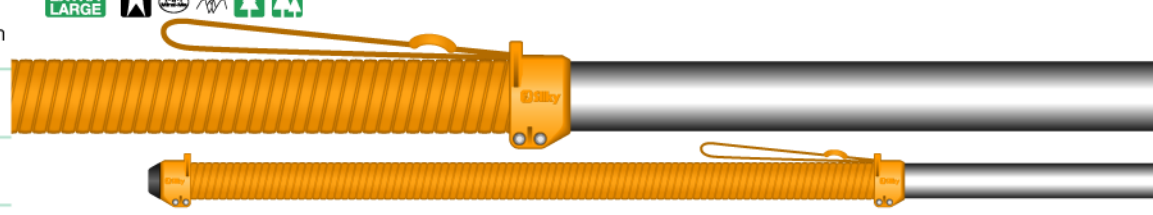

Extension range 2400 ~ 6100 mm 7.9 ~ 20 ft.

98

LONGBOY

2-extensions
 Blade length 360 mm / 14.2 inch
 Teeth/30mm 7.5 large teeth
 SAW:Code No. 365-36
 Box/Cartron 1
 Barcode No. 4903585365365
 BLADE:Code No. 366-36
 Box/Cartron 10/-
 Barcode No. 4903585366362

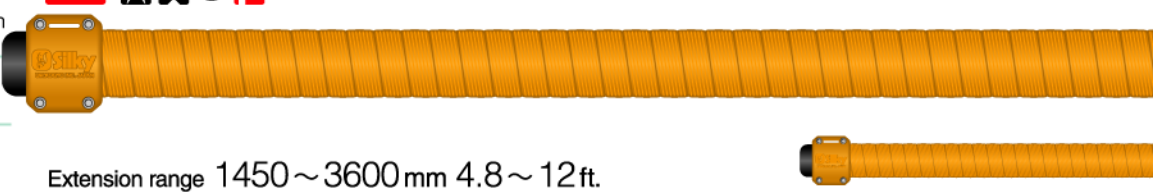

Extension range 1450 ~ 3600 mm 4.8 ~ 12 ft.

99

TODOKU

Blade length 390 mm / 15.4 inch
 Teeth/30mm 6.5 extra large teeth
 SAW:Code No. 433-17
 Box/Cartron -
 Barcode No. 4903585433170
 Blade with cover & pipe:Code No. 431-39
 Box/Cartron -
 Barcode No. 4903585431398



2350 mm 7.7 ft. 4050 mm 13.3 ft. 5750 mm 18.9 ft.
 Extension range base pole & blade assembly + one extension pole + two extension poles

COMPLETE PACKAGE

- 1.8 M (6-Foot) Base Pole with Black Rubber Overgrip - 1 pcs
- 1.8 M (6-Foot) Extension Pole without Overgrip - 2 pcs
- Blade Assembly (blade, pipe and cover) - 1 pcs
- Carrying Bag - 1 pcs

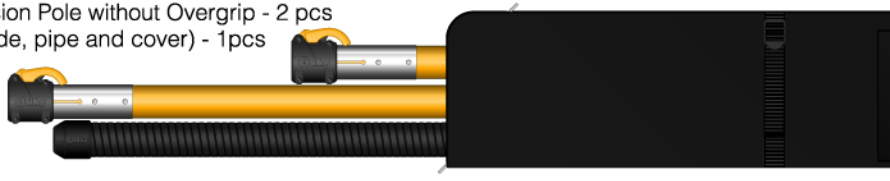

100



EXTENSION POLE 1800 mm 6 ft. without Overgrip



BASE POLE 1800 mm 6 ft. with Black Rubber Overgrip



HOOKFOX for HAYATE / HAYAUCHI / LONGBOY

Code No. 425-01
 Box/Cartron
 Barcode No. 4903585425014

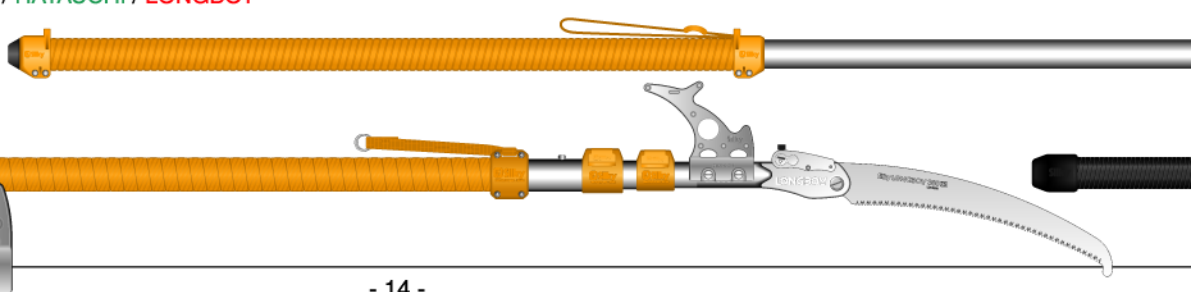

101

No.427-39 HAYATE IPPON (2,480mm / 8-feet fixed length pole saw) is also available.

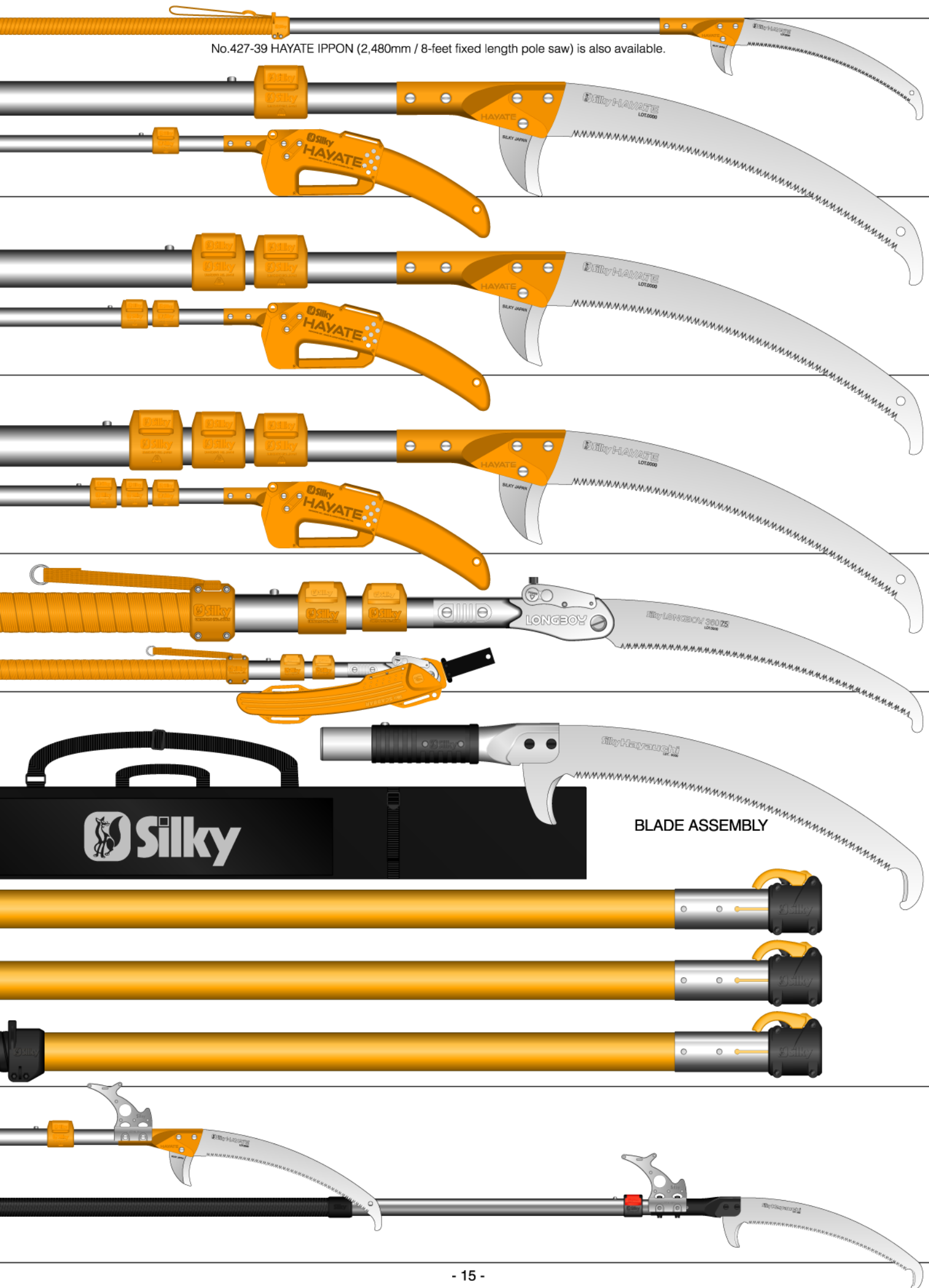

BLADE ASSEMBLY

ICON DESCRIPTIONS (for USE)

**EXTRA
LARGE**

LARGE

MEDIUM

FINE

**EXTRA
FINE**



FORESTRY

SE Stamkivstning
D Forst Pflege
GB Forestry maintenance
F La silviculture
NL Bosbouw onderhoud
I Silvicultura
E Silvicultura



PRUNING

SE Trädgård
D Garten
GB Gardening
F Jardiner
NL Tuinieren
I Giardianaggio
E Jardinear



CONSTRUCTION

SE Byggnation
D Bau
GB Construction
F Bâtiment
NL Bouw
I Costruzione
E Construcción



WOOD WORKING

SE Snickerier/-arbeiten
D Holzbearbeitung
GB Wood-working
F travail du bois
NL Houtbewerking



DIY & HOBBY

SE Hobby
D DIY & Hobby
GB DIY & Hobby
F Bricolage & Hobby
NL DH-Z & Hobby
I Bricolage e hobby
E Bricolaje & Hobby



ARBORIST

SE Arborist
D Baumpflege
GB Arborist
F Arboriculture
NL Boomverzorging
I Arboricoltura
E Arboles Ornamentales



CONSTRUCTION

SE Byggnation
D Bau
GB Construction
F Bâtiment
NL Bouw
I Costruzione
E Construcción



PRUNING

SE Trädgård
D Garten
GB Gardening
F Jardiner
NL Tuinieren
I Giardianaggio
E Jardinear



BAMBOO CUTTING

SE Bambusåkning
D Sägen von Bambus
GB Bamboo cutting
F Scier du bambou
NL Zagen van bamboe
I Segare bambù
E Serrar de bambú



WOOD WORKING

SE Snickerier/-arbeiten
D Holzbearbeitung
GB Wood-working
F travail du bois
NL Houtbewerking



ROOT CUTTING

SE Rotbeskärning
D Wurzel schneiden
GB Root cutting
F Taille de racines
NL Wortel snoeien
I Taglio radici
E Poda De raíces

ICON DESCRIPTIONS (for FUNCTION)



Impulse-hardening

SE Impulshårdat
D Impulsiv gehärtet
GB Impulse hardening
F Durci impulsivement
NL Impulsief gehard
I Indurimento intensivo
E Endurecido impulsivamente



Non-set Teeth

SE Koniskt
D Konisch
GB Conical
F Conique
NL Konisch
I Conico
E Conico



Mirai-Me

SE Fint snitt
D Feine Holzschitt
GB Smooth cutting
F Coupe le bois finement
NL Fijne houtsnede
I Taglie il legno finemente
E Acero al cromo endurecido



Four rows of teeth

SE Fyra tandrader
D Vier Reihe Zähne
GB Four rows of teeth
F Quatre rangées de dents juxtaposées
NL Vier rijen tanden
I Quattro file di denti jüstapposte
E Cuatro filas de dientes



Sharpenable

SE Kan slipas
D Es ist zu feilen
GB Sharpenable
F Affûtable
NL Vlijen mogelijk
I Affilabile
E Afilable



FPA-ANERKANNT
FPA-approved in Germany